

# MATRICE 30 SERIES

## Maintenance Manual v1.0

2022.09

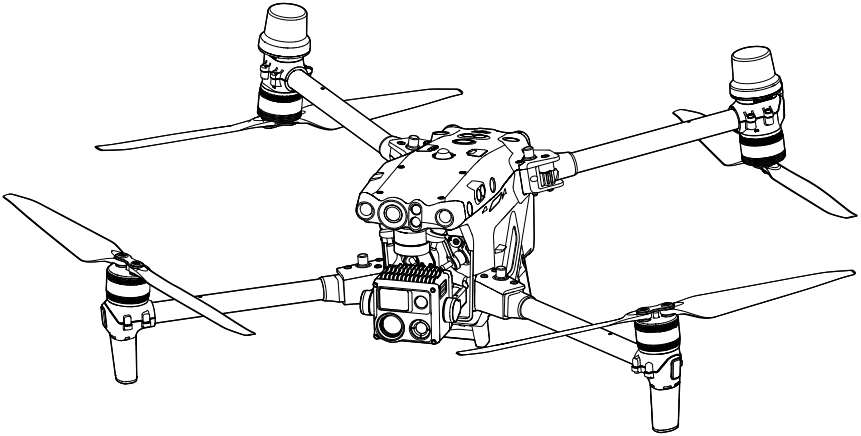



This document is copyrighted by DJI with all rights reserved. Unless otherwise authorized by DJI, you are not eligible to use or allow others to use the document or any part of the document by reproducing, transferring or selling the document. Users should only refer to this document and the content thereof as instructions to operate DJI UAV. The document should not be used for other purposes.

### **Searching for Keywords**

Search for keywords such as “battery” and “install” to find a topic. If you are using Adobe Acrobat Reader to read this document, press Ctrl+F on Windows or Command+F on Mac to begin a search.

### **Navigating to a Topic**

View a complete list of topics in the table of contents. Click on a topic to navigate to that section.

### **Printing this Document**

This document supports high resolution printing.

# Contents

<b>Introduction</b>	2
<b>Disclaimer</b>	2
<b>Safety Flight Guidelines</b>	2
Flight Condition Requirements	2
Operational Requirements	2
Flight Restrictions	2
Storage and Transportation	3
Firmware Update	3
<b>Inspection and Maintenance</b>	3
Pre-Flight Checklist	3
Regular Maintenance	4
Regular Maintenance Items	4
Propulsion System	4
Flight Controller	6
Aircraft Structure	6
Battery	10
List of Updates and Calibrations	11
List of Wearing Parts	11
Health Management System	12
DJI Maintenance Service	15
<b>After-sales Service</b>	17
Warranty Policy	17
Warranty Period for Aircraft Parts (12 months for the whole machine)	17
Warranty Period for Other Parts	17
Handling Procedures for Flight Accident	18
Flyaway Accident	18
Collision or Crash Accident	18
Shipping the Product for Repair	18

# Introduction

This Maintenance Manual offers guidelines to help you in the daily upkeep and maintenance of the aircraft, and also provides after-sales service information.

This document focuses on the maintenance instructions and the notes, cautions, and warnings during use. Read the User Manual and Maintenance Manual carefully to optimize user experience. If you have any questions on the maintenance operations, please contact DJI Support.

## Disclaimer

Carefully read this entire document and all safe and lawful practices provided by DJI™ before using this product for the first time. Failure to read and follow instructions and warnings may result in serious injury to yourself or others, damage to your DJI product, or damage to other objects in the vicinity. By using this product, you hereby signify that you have read this document carefully and understand and agree to abide by all terms and conditions of this document and all relevant documents of this product. You agree that you are solely responsible for your own conduct while using this product and for any consequences thereof. DJI accepts no liability for damage, injury, or any legal responsibility incurred directly or indirectly from the use of this product.

DJI is a trademark of SZ DJI TECHNOLOGY CO., LTD. (abbreviated as “DJI”) and its affiliated companies. Names of products, brands, etc., appearing in this document are trademarks or registered trademarks of their respective owner companies. This product and document are copyrighted by DJI with all rights reserved. No part of this product or document shall be reproduced in any form without the prior written consent or authorization of DJI. This document and all other collateral documents are subject to change at the sole discretion of DJI. This content is subject to change without prior notice. For up-to-date product information, visit <http://www.dji.com> and click on the product page for this product.

## Safety Flight Guidelines

### Flight Condition Requirements

#### Operational Requirements

Before use, read the Disclaimer and Safety Guidelines, User Manual, and Maintenance Manual carefully.

#### Flight Restrictions

1. Connect the aircraft to the internet to update the database of DJI GEO Zones regularly. Consult the relevant local government agencies or governing bodies before flight to ensure you comply with all the relevant laws and regulations.
2. If flying in GEO Zones is required, apply for unlocking in advance.  
<https://www.dji.com/flysafe>

## Storage and Transportation

There are safety requirements for the storage and transportation of the Intelligent Flight Batteries. Please strictly follow these Intelligent Flight Battery Safety Guidelines.

## Firmware Update

To optimize the experience, it is recommended to keep the firmware of the aircraft, Intelligent Flight Batteries and remote controller up to date before each flight. Refer to the User Manual for instructions on running a firmware update.

If the firmware update fails, restart the device and try again. Contact DJI Support if the issue persists.

## Inspection and Maintenance

Routine inspection before operations or regular maintenance can greatly improve the aircraft's reliability, reduce potential safety hazards, and extend its service life.

## Pre-Flight Checklist

The pre-flight checklist can be used as a reference for pre-flight check in daily operations.

1. Make sure the remote controller and the aircraft batteries are fully charged, the TB30 batteries are installed firmly, and the battery release toggles are locked.
2. Make sure the propellers are securely mounted and not damaged or deformed, that there are no foreign objects in or on the motors or propellers, the propeller blades and arms are unfolded, and that the frame arm folding buttons are popped out in the locked position.
3. Make sure the lenses of the vision systems, cameras, FPV, the glass of the infrared sensors, and the auxiliary lights are clean and not blocked in any way.
4. Make sure the gimbal is unlocked and the camera is facing the front of the aircraft.
5. Make sure the covers of the microSD card slot, OSDK port, and dongle compartment have been closed firmly.
6. Make sure the remote controller antennas are adjusted to the proper position.
7. Power on the aircraft and the remote controller, toggle the flight mode switch to N-mode. Make sure the status LED and the aircraft authority button on the remote controller are solid green. This indicates that the aircraft and the remote controller are linked and the remote controller is in control of the aircraft.
8. Place the aircraft on open and flat ground. Make sure there are no obstacles, buildings, or trees nearby, and that the aircraft is 5 m away from the pilot. The pilot should be facing the rear of the aircraft.
9. To ensure flight safety, enter the camera view of DJI Pilot 2 and check the parameters on the pre-flight checklist such as the failsafe settings, control stick mode, RTH height, and obstacle distance. It is recommended to set the out-of-control action to RTH.
10. Divide the airspace for flight when multiple aircraft are operating simultaneously in order to avoid collision mid-air.

## Regular Maintenance

It is recommended to perform inspection and maintenance regularly by following the standards below to keep the aircraft in a good condition and reduce safety risks.

Type	Maintenance Items	Maintenance Advice	Period *
Basic Maintenance	Deep cleaning, regular maintenance items, updates and calibrations	It is recommended to return to the factory or contact an authorized agent	According to users' actual requirements
Routine Maintenance	Deep cleaning, regular maintenance items, updates and calibrations, components replacement due to wear and tear	Factory service	Per 300-hour flights / Per year**
Maintenance	Deep cleaning, regular maintenance items, updates and calibrations, components replacement due to wear and tear, propulsion system component replacement	Factory service	Per 900-hour flights / Per three years**

\* The time specified in the maintenance period or the flight time shall be whichever comes first.



\*\* Per year/Per three years expresses the device activation time.

 For various regions, DJI will adjust the maintenance type and period. Contact your local dealer or DJI Support for the latest service details.

## Regular Maintenance Items

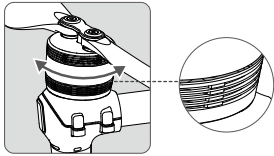
### Propulsion System

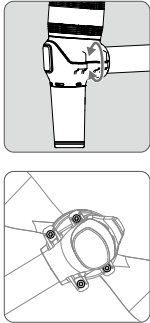
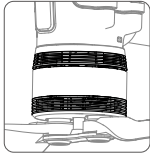
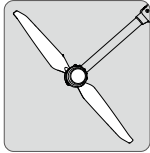
Type	Inspection Process	Illustrations
Motor Rotation	<ol style="list-style-type: none"> <li>1. Unfold and secure the frame arms.</li> <li>2. Rotate the rotor of the motor to check if there is any blockage or rubbing. Observe the gap between the rotor and stator of the motor to check if there is any rubbing with the motor base.</li> <li>3. DO NOT fly the aircraft if there is any blockage or rubbing mentioned above. It is necessary to return to the factory for repair.</li> </ol>	

<p>Connection between Motor and Arm</p>	<ol style="list-style-type: none"> <li>1. Rotate the motor base around the central line of carbon tube to check if the motor and carbon tube connection is loose.</li> <li>2. The four fixing screws are secure.</li> <li>3. If any screw is loose, return to the factory for repair.</li> </ol>	
<p>Motor Air Filters</p>	<ol style="list-style-type: none"> <li>1. Air filters are not severely misshapen or damaged.</li> <li>2. If they are severely misshapen (such as being bumped) or damaged, return to the factory for repair.</li> </ol>	
<p>Propellers</p>	<ol style="list-style-type: none"> <li>1. Check the propellers for visible deformation, severe wear, nicks, and cracks, and if there are any foreign materials.</li> <li>2. Clean the propellers with a dry soft cloth.</li> <li>3. Replace the propellers immediately if visible deformation, severe wear, nicks, or cracks occur. *</li> <li>4. Replace the propellers after flying over 300 hours or using for one year. *</li> </ol>	
<p>Propeller Adapters</p>	<ol style="list-style-type: none"> <li>1. The propeller adapter screws are secure.</li> <li>2. If the screws are loose, apply thread locker and tighten the screws.</li> <li>3. The propeller adapters are not misshapen or broken.</li> <li>4. Replace the propeller adapters if they are misshapen or damaged.</li> </ol>	

\* It is recommended to replace the propellers only in an emergency situation during operations. After the emergency flight is over, please contact DJI Support or an authorized dealer for overhaul as soon as possible.

## Flight Controller

1. After the aircraft is powered on and self-check is complete, there are no error prompts in the app related to the flight controller.
2. In outdoor open environments, the GNSS signal reaches “Strong” level within 1 minute of powering on the aircraft, indicating that the Home Point can be recorded automatically, and the RTK data meets the heading measurement standard.
3. In outdoor open environments, the interference of the compass after calibration is less than 50.
4. Sensor bias is less than 0.05 after the IMU calibration.

## Aircraft Structure

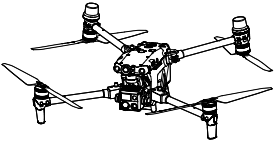
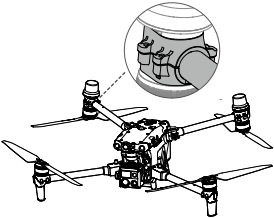
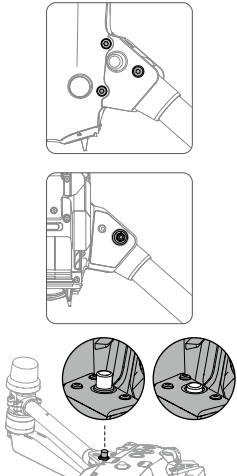
Type	Inspection Process	Illustrations
Aircraft Appearance	<ol style="list-style-type: none"> <li>1. The aircraft body is clean and not damaged.</li> <li>2. Clean the aircraft body with a clean and soft cloth, especially for the lenses of the infrared sensing and vision systems and the heat dissipation vents.</li> </ol>	
Screws	<ol style="list-style-type: none"> <li>1. All the screws on the aircraft body are tightened, especially the screws connecting the motor and the carbon tube.</li> </ol>	
Frame Arms	<ol style="list-style-type: none"> <li>1. The 12 screws on the four frame arms are secure.</li> <li>2. The screw nuts attached on the shaft screws are secure when rotating the frame arms.</li> <li>3. The arm junctions are not damaged or cracked.</li> <li>4. The frame arm folding buttons can pop out smoothly so that the frame arms are unfolded and locked firmly.</li> <li>5. The frame arm folding buttons can be pressed down smoothly when the arms are folded.</li> </ol>	

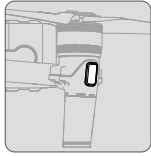
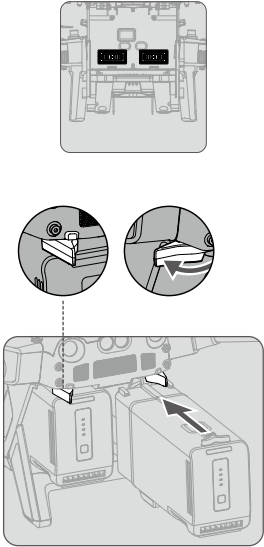
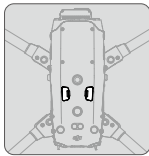

<p>Frame Arm LEDs</p>	<ol style="list-style-type: none"> <li>1. There is no foreign object or damage on the surface.</li> </ol>	
<p>Battery Compartment</p>	<ol style="list-style-type: none"> <li>1. The battery ports are clean and dry without any corrosion. Remove any water or dust if present.</li> <li>2. The screws on the battery release toggles are secure.</li> <li>3. The battery release toggles spring back normally after being toggled.</li> <li>4. After the battery is installed, the battery release toggle can spring back normally without obvious shaking.</li> </ol>	
<p>Data Ports</p>	<ol style="list-style-type: none"> <li>1. Clean any unwanted residue near the ports with a gauze.</li> <li>2. If the ports are in use, disconnect the cables, and then check for any unwanted residue in the ports with the help of a light.</li> <li>3. Remove any foreign objects such as small pieces of stone or paper in the ports using tweezers.</li> <li>4. Clean any adhesive materials that are in the port with a gauze.</li> <li>5. Place the aircraft at an angle and use a gauze or brush to remove any fine materials such as dust from the port. Note clean thoroughly, sweeping away from the port.</li> </ol>	

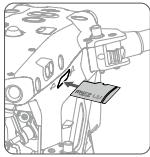
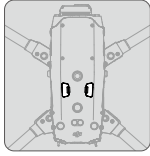
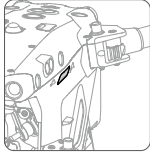
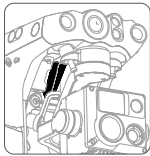
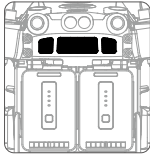
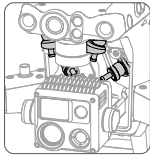
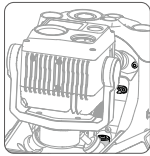
<p>microSD Card Information</p>	<ol style="list-style-type: none"> <li>1. Check if there are any foreign objects in the microSD card slot and if the microSD is installed correctly.</li> <li>2. Check if the microSD card is working properly.</li> </ol>	
<p>Rubber Port Covers</p>	<ol style="list-style-type: none"> <li>1. The rubber port covers are not damaged or loose.</li> </ol>	 
<p>Heat Dissipation Vents</p>	<ol style="list-style-type: none"> <li>1. The heat dissipation vents are not blocked. The cooling fans work smoothly without noise.</li> </ol>	 
<p>Gimbal Damping Plate</p>	<ol style="list-style-type: none"> <li>1. The dampeners are not damaged, loose, or aged.</li> <li>2. The screws connecting the damping plate and aircraft body are secure.</li> </ol>	 

Gimbal  
Camera

1. Rotate the gimbal pitch axis to +90° so that the camera can be locked.
2. The lenses on the camera are not damaged or cracked.

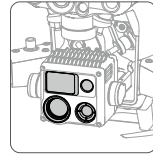
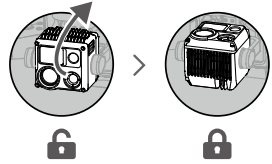

Infrared  
Sensing  
and Vision  
System  
Lenses,  
Auxiliary  
Lights, and  
Beacons

1. Clean the lenses with a soft cloth.
2. Lenses are not loose and have no cracks.
3. The auxiliary lights and beacons are not loose or cracked.

Infrared Sensing and Vision Systems

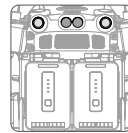
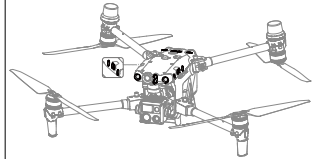

Rear View

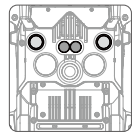

Bottom View

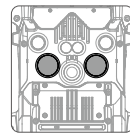

Auxiliary Lights

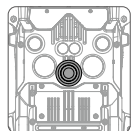
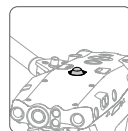

Beacons

## Battery

### Battery Maintenance Conditions

Maintenance is required when any of the events below occur.

1. Every 50 cycles.
2. The battery is idle for more than three months.
3. There is a maintenance prompt in the app.

### Checklist for Maintenance

1. Charge and discharge the battery as per instructions.
2. Insert the battery into the aircraft and power on to view the battery information in DJI Pilot 2. Make sure the difference in cell voltage is less than 0.1 V and the battery firmware is updated to the latest version.
3. Make sure the battery is not swollen, leaking, or damaged.
4. Make sure battery terminals are clean.

### Standard Charge and Discharge Operation Instructions

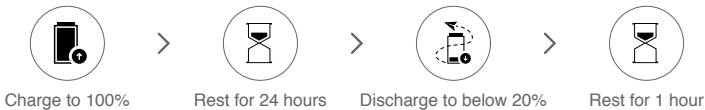

1. Charge the battery to 100% and let the battery sit for 24 hours.
2. Install the battery into the aircraft and take off. Land the aircraft and remove the battery when the remaining power level is 20% or lower.
3. Let the battery sit for one hour.
4. Charge the battery fully or to the proper power level for storage after completing battery maintenance.

### Battery Replacement Standard

1. The battery is visibly swollen, leaking, or damaged.
2. The battery is rated for 400 cycles. It is not recommended to continue use afterward.
3. The battery error still exists after performing the standard charge and discharge operations twice continuously.

### Battery Disposal

1. Make sure to remove the protective plastic sheet on the side of the battery before fully immerse the battery in an insulated bucket with 5% salt solution. Leave the battery in the solution for more than 48 hours to fully discharge the battery.

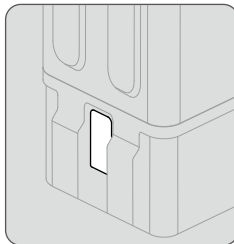

- It is recommended to recycle the battery by following the Intelligent Flight Battery Safety Guidelines to avoid environmental pollution.

**Warnings**

- It is recommended to charge and discharge the battery in a special explosion-proof cabinet.
- DO NOT use the battery in a humid environment to avoid short circuits.
- Never disassemble or pierce the battery in any way.
- Store Intelligent Flight Batteries in a well-ventilated and dry place.
- Initiate RTH immediately when the app prompts that the battery temperature is too high.

**List of Updates and Calibrations**

It is recommended to update the firmware of the aircraft and the remote controller in time, and perform calibration regularly to keep the aircraft in the best condition.

No.	Category
1	Aircraft firmware update
2	Remote controller firmware update
3	IMU calibration
4	Compass calibration
5	Vision system calibration
6	Gimbal calibration

**List of Wearing Parts**

Replace parts that are easily damaged and worn in time to maintain the best flight results and reduce potential safety hazards.

No.	Category	Quantity
1	CW propeller blade *	4
2	CCW propeller blade *	4
3	Motor **	4
4	Rear landing gear on the lower cover	1
5	Landing gear with the video transmission antenna inside	2
6	Upper cover of the frame arm connector	4
7	Battery release toggle	2
8	Air inlet filter	1
9	Air outlet filter	1
10	Remote controller control stick cap	2

\* Each motor is used with two CW propeller blades or two CCW propeller blades.

\*\* Replace only for deep maintenance.

## Health Management System

Users can view the status of each module and upload the log with an abnormal status in the Health Management System (HMS) page in DJI Pilot 2.

1. Enter the HMS page in DJI Pilot 2.

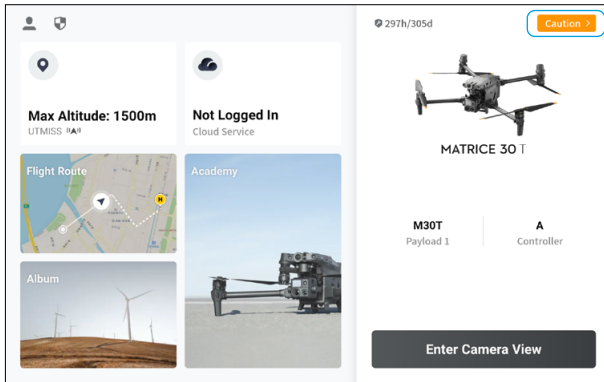

2. View the health condition of each module of the connected device.

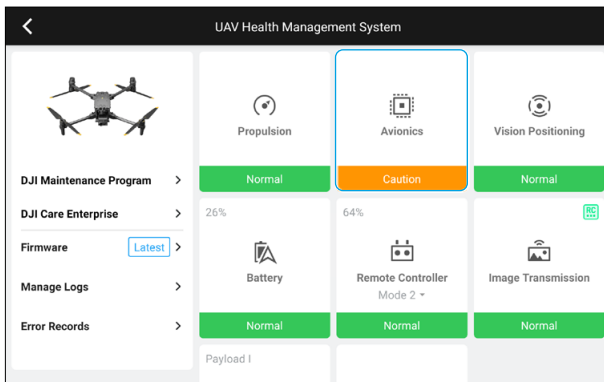

3. If any module is abnormal, tap to view the warning message.

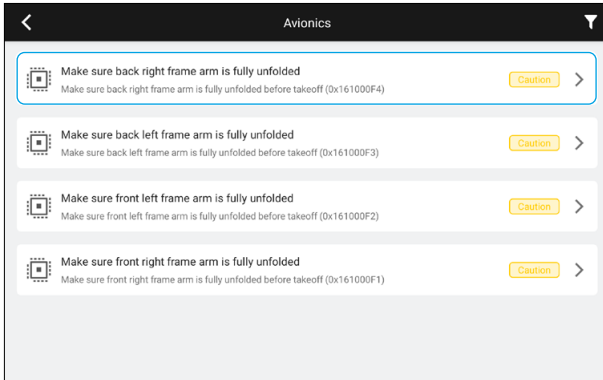

4. Tap the warning message to view the help document for troubleshooting. If the abnormal status still exists after check by following the document, users can upload the log, send the QR code or the tracking number to DJI Support for help.

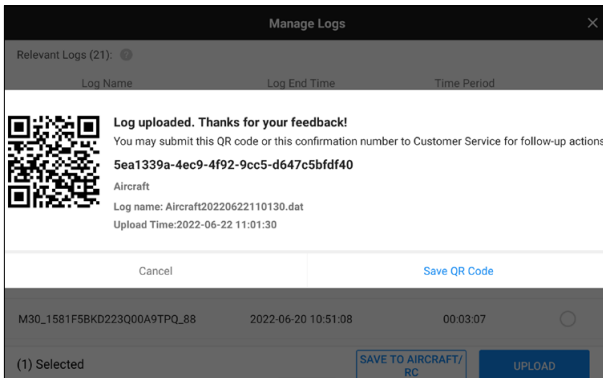
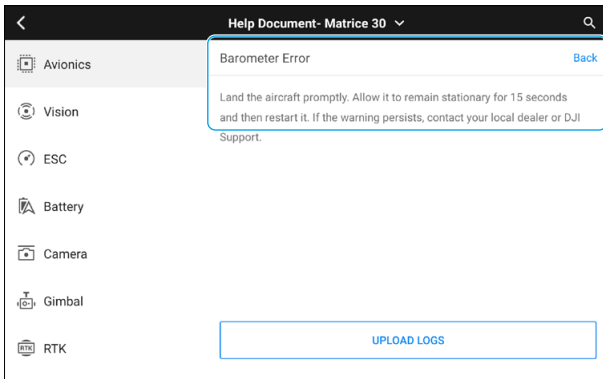

5. At the same time, users can tap the log management to select the aircraft, remote controller, and battery station\* with abnormal flights according to the log deadline to upload logs.

\* The battery station USB-C maintenance port must be connected to the remote controller USB-A port by using a cable when exporting the battery station log.

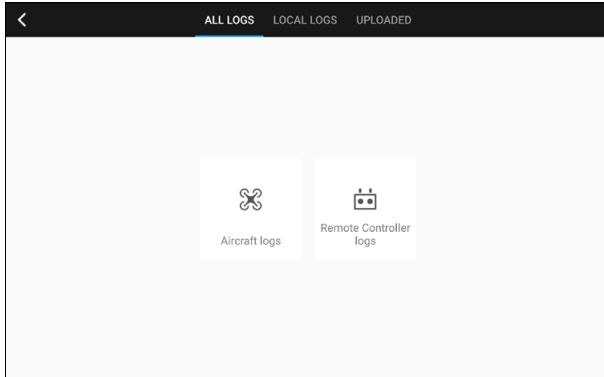
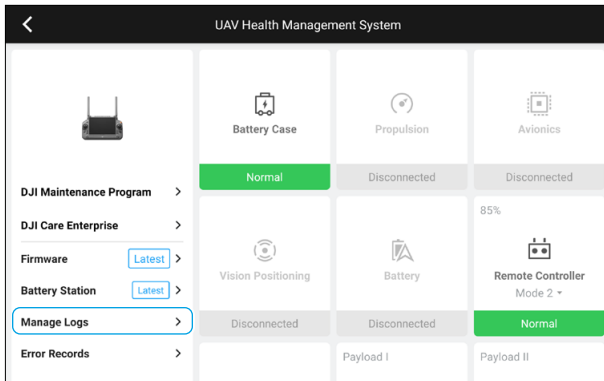

**Manage Logs** [Close]

Relevant Logs (21): [Filter]

Log Name	Log End Time	Time Period	
M30_1581F5BKD223Q00A9TPQ_93	2022-06-22 10:50:16	00:24:16	<input checked="" type="checkbox"/>
M30_1581F5BKD223Q00A9TPQ_92	2022-06-21 20:52:49	00:21:41	<input type="checkbox"/>
M30_1581F5BKD223Q00A9TPQ_91	2022-06-21 18:15:57	01:44:00	<input type="checkbox"/>
M30_1581F5BKD223Q00A9TPQ_90	2022-06-20 13:04:30	01:55:29	<input type="checkbox"/>
M30_1581F5BKD223Q00A9TPQ_89	2022-06-20 11:08:54	00:01:31	<input type="checkbox"/>
M30_1581F5BKD223Q00A9TPQ_88	2022-06-20 10:51:08	00:03:07	<input type="checkbox"/>

(1) Selected

[SAVE TO AIRCRAFT/RC] [UPLOAD]



## DJI Maintenance Service

1. Tap Maintenance Service in HMS.

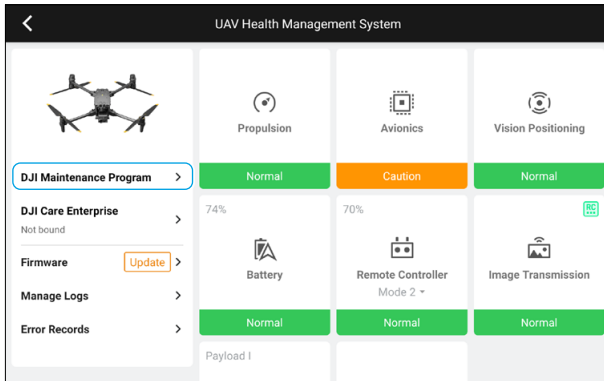

2. View the flight data and maintenance items of the current devices.

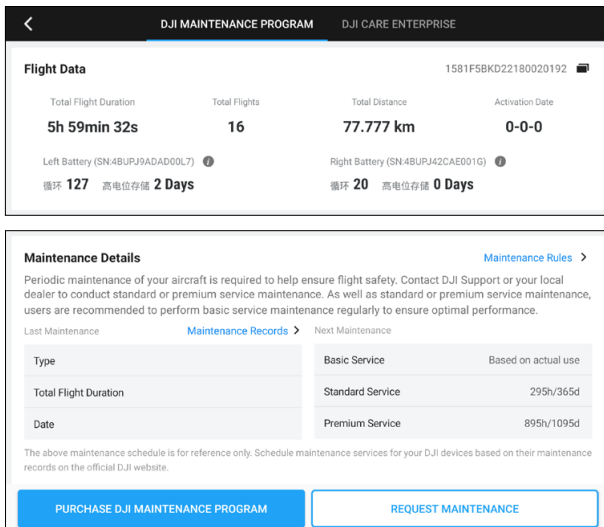

3. When the battery life and device maintenance time are approaching, the text color will be indicated in orange.

<
DJI MAINTENANCE PROGRAM
DJI CARE ENTERPRISE

**Flight Data** 1581F5BKD22180020192

Total Flight Duration	Total Flights	Total Distance	Activation Date
<b>5h 59min 32s</b>	<b>16</b>	<b>77.777 km</b>	<b>0-0-0</b>

Left Battery (SN:4BUPJ9ADAD00L7)

循环 **127** 高电位存储 **2 Days**

Right Battery (SN:4BUPJ42CAE001G)

循环 **20** 高电位存储 **0 Days**

Left Battery (SN:4BUPJ9ADAD00L7)

循环 **127** 高电位存储 **66 Days**

Right Battery (SN:4BUPJ42CAE001G)

循环 **20** 高电位存储 **66 Days**

Left Battery (SN:4BUPJ9ADAD00L7)

循环 **127** 高电位存储 **150 Days**

Right Battery (SN:4BUPJ42CAE001G)

循环 **20** 高电位存储 **150 Days**

**Maintenance Details** [Maintenance Rules >](#)

Periodic maintenance of your aircraft is required to help ensure flight safety. Contact DJI Support or your local dealer to conduct standard or premium service maintenance. As well as standard or premium service maintenance, users are recommended to perform basic service maintenance regularly to ensure optimal performance.

Last Maintenance
Maintenance Records >
Next Maintenance

Type	Basic Service	Based on actual use
Total Flight Duration	Standard Service	295h/365d
Date	Premium Service	895h/1095d

Type	Basic Service	Based on actual use
Total Flight Duration	Standard Service	12h/365d
Date	Premium Service	612h/1095d

Type	Basic Service	Based on actual use
Total Flight Duration	Standard Service	900h overdue
Date	Premium Service	300h overdue

The above maintenance schedule is for reference only. Schedule maintenance services for your DJI devices based on their maintenance records on the official DJI website.

# After-sales Service

## Warranty Policy

Warranty period may vary according to local laws and regulations.

### Warranty Period for Aircraft Parts (12 months for the whole machine)

Aircraft Parts	Warranty Period
Flight Control System	12 Months
Aircraft Body	12 Months
Motor	12 Months
ESC	12 Months
Antenna	12 Months
Gimbal Camera	12 Months

### Warranty Period for Other Parts

Other Parts	Warranty Period
TB30 Intelligent Flight Battery	12 Months (for batteries with up to 400 charge cycles and stored with a charge of 90% or above for no more than 120 days)
BS30 Intelligent Battery Station	12 Months
Intelligent Remote Controller	12 Months
DJI Cellular Dongle *	12 Months
WB37 Intelligent Battery*	12 Months
PSDK Mounting Bracket*	3 Months
Carrying Box	3 Months

\* Excluded accessories.



Visit <https://www.dji.com/service/policy> to view product warranty period and warranty policy.

## Handling Procedures for Flight Accident

When your aircraft encounters a flight accident, please follow below steps below to handle it.

### Flyaway Accident

1. Contact DJI Support as soon as possible to describe the accident;
2. View the flight record in DJI Pilot 2, and look for the aircraft around the data interruption location based on the actual terrain;
3. Connect the remote controller to the computer, export the flight control system data and flight records, and contact DJI Support or local dealers for assistance in applying for data analysis;
4. DJI will provide a solution based on the analysis results.

### Collision or Crash Accident

1. Take photos of the aircraft status and surrounding environment in time after the accident, and record the aircraft status and the accident process before the accident;
2. Make sure the aircraft is powered off, remove the batteries from the aircraft, and use an isolation box to store the batteries. Note: DO NOT power on the aircraft again if the accident is serious, otherwise it may damage the internal circuit of the aircraft and cause greater loss;
3. Connect the remote controller to the computer, export the flight control system data and flight records, and contact DJI Support or local dealers for assistance in applying for data analysis;
4. Ship the device for repair.

## Shipping the Product for Repair

You can choose one of the methods below to ship the product for repair according to the actual situation.

1. Official website self-service repair:

Visit the official website of the DJI Service Center <https://repair.dji.com/repair/index>, and follow the instructions to complete the self-service repair service.

2. Contact your local dealer for assistance:

Contact your local dealer and describe the product's issue. The dealer can assist you to send the product for repair.

3. DJI Support hotline service:

Contact DJI Support to describe the product's issue and service type, such as repair, return or replace, and ship the product back according to the guidelines.

Visit the following website to view phone support options for hotline service:

<https://www.dji.com/support>



Contact  
DJI SUPPORT

---

This content is subject to change without notice.

Download the latest version from



<https://www.dji.com/matrice-30/downloads>

If you have any questions about this document, please contact DJI by sending a message to **DocSupport@dji.com**.